

Leonid Landsberg: 1930–2005

Was interested in many areas of physics.

Structure and properties of mesons and baryons: searches for quarks; searches for new hadronic states, including exotics; searches for new decay modes; improvements in limits and precision. Quite naturally:

Hyperon Radiative Decays

Review:

L.G.Landsberg

Yad. Fiz. 59 (1996) 2161–2186

Phys. Atom. Nucl. 59 (1996) 2080–2104

“Radiative decays of hyperon resonances”

Overview of the talk:

- Hyperons
- Old measurements
- Recent measurements
- Future

Octet and Decuplet

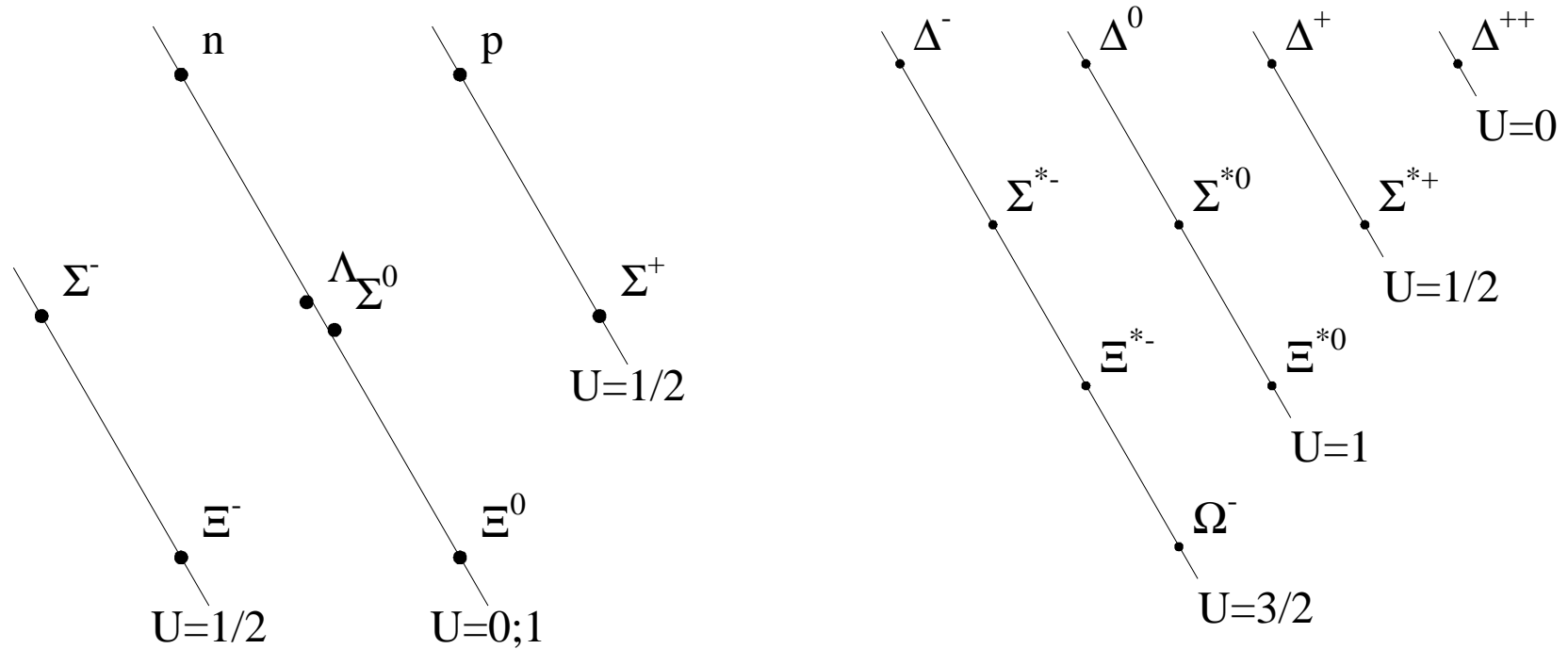

$$|00\rangle = \frac{\sqrt{3}}{2} \Sigma^0 - \frac{1}{2} \Lambda$$

$$|10\rangle = \frac{1}{2} \Sigma^0 + \frac{\sqrt{3}}{2} \Lambda$$

$$\Sigma^0 = \frac{\sqrt{3}}{2} |00\rangle + \frac{1}{2} |10\rangle$$

$$\Lambda = \frac{\sqrt{3}}{2} |10\rangle - \frac{1}{2} |00\rangle$$

Higher mass states

There are many, but two are of special interest:

- $\Lambda(1405)$

$$M = 1406.5 \pm 0.4 \text{ MeV}$$

$$\Gamma = 50 \pm 2 \text{ MeV}$$

- $\Lambda(1520)$

$$M = 1519.5 \pm 1.0 \text{ MeV}$$

$$\Gamma = 15.6 \pm 1.0 \text{ MeV}$$

While having quite complex structure in terms of quark model description, these states are experimentally well defined:

- firmly established
- quite narrow
- no overlapping resonances (like in 1670 MeV region)

Nature of $\Lambda(1405)$

(a) Charmed baryons

(b) Light strange baryons

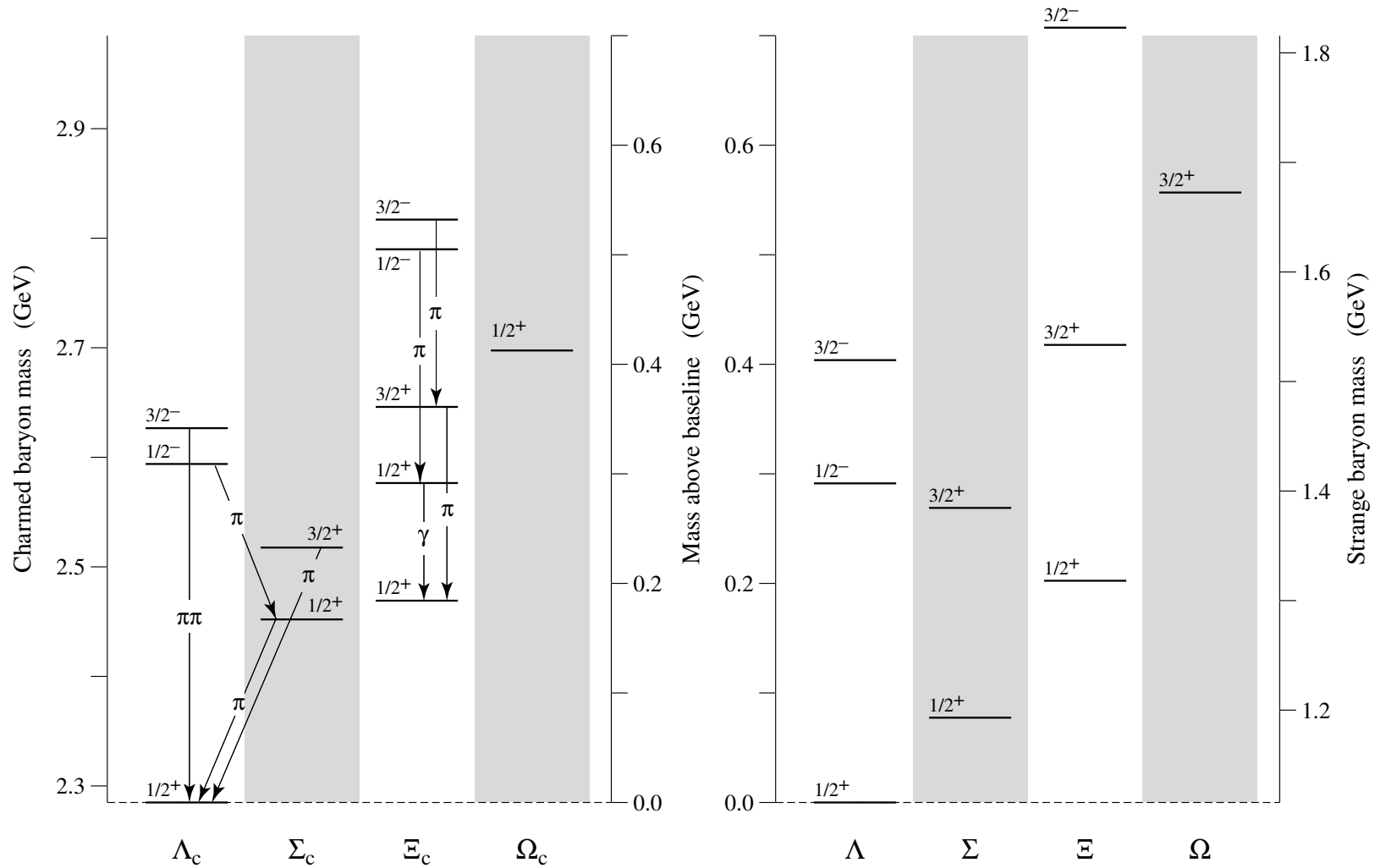

Main radiative transitions

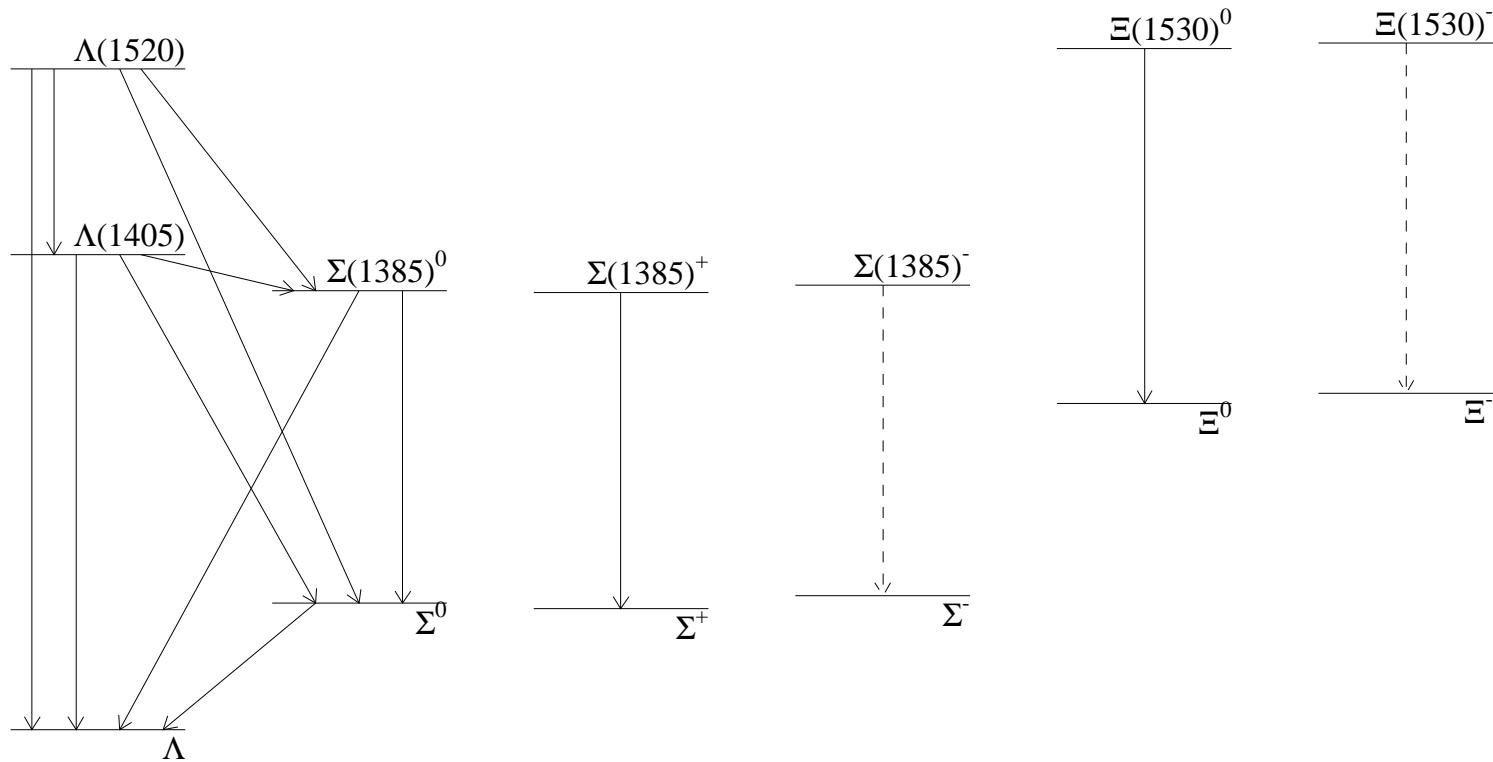

Our Knowledge In 1996

	Decay	Γ [keV]	1996	
86	$\Sigma^0 \rightarrow \Lambda \gamma$	8.9 ± 1.0	●	<ul style="list-style-type: none"> ● About 10 theoretical papers ● $\Sigma^0 \rightarrow \Lambda \gamma$ is the only sufficiently precise and non-controversial measurement
	$\Sigma(1385)^+ \rightarrow \Sigma^+ \gamma$			
77	$\Sigma(1385)^- \rightarrow \Sigma^- \gamma$	<24	*	
75	$\Sigma(1385)^0 \rightarrow \Sigma^0 \gamma$	<1750	*	
75	$\Sigma(1385)^0 \rightarrow \Lambda \gamma$	<2000	*	
	$\Lambda(1405) \rightarrow \Sigma(1385)^0 \gamma$			
91	$\Lambda(1405) \rightarrow \Sigma^0 \gamma$	19 ± 4 or 23 ± 7	●	
91	$\Lambda(1405) \rightarrow \Lambda \gamma$	27 ± 8	●	
	$\Lambda(1520) \rightarrow \Lambda(1405) \gamma$			
	$\Lambda(1520) \rightarrow \Sigma(1385)^0 \gamma$			
87	$\Lambda(1520) \rightarrow \Sigma^0 \gamma$	47 ± 11	●	
68,87	$\Lambda(1520) \rightarrow \Lambda \gamma$	134 ± 23 and 31 ± 11	●	
	$\Xi(1530)^- \rightarrow \Xi^- \gamma$			
	$\Xi(1530)^0 \rightarrow \Xi^0 \gamma$			

New developments

- Theory:

collective approach in 3-flavor Skyrme

HB χ PT

chiral CQM with EM exch. curr.

algebraic model of hadron structure

$1/N_c$ expansion of QCD

light cone QCD

Bonn CQM

Abada:1996db, Haberichter:1997cp

Napsuciale:1997ny

Wagner:1998bu, Wagner:2000ii

Bijker:2000gq

Lebed:2004zc

Aliev:2004ju

VanCauteren:2005sm

- Pentaquark $\Theta(1540)^+$ connection

Y.Oh, K.Nakayama and T.S.Lee. hep-ph/0511198.

$\Lambda(1520)$ radiative decays are of interest for understanding strangeness

photoproduction mechanisms

- Experiment:

SELEX FNAL

SPHINX Protvino

CLAS JLAB

SELEX Detector

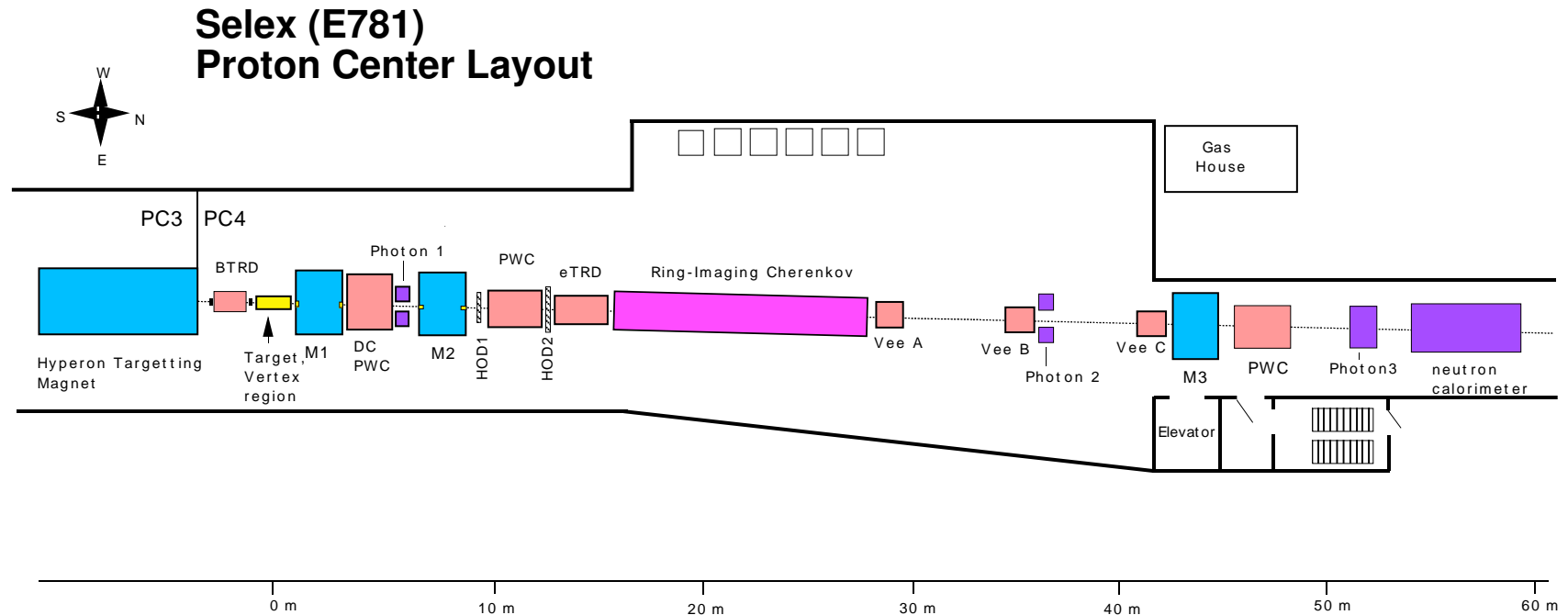

Search for Primakoff $\Sigma(1385)^-$ production

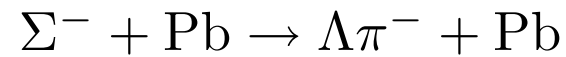

SELEX: $\Sigma(1385)^- \rightarrow \Sigma^- \gamma$

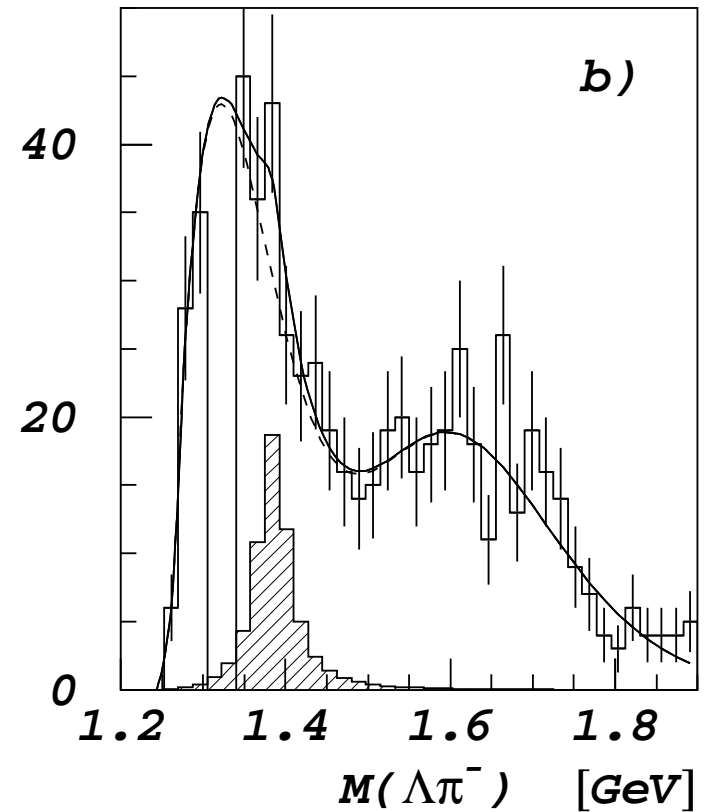
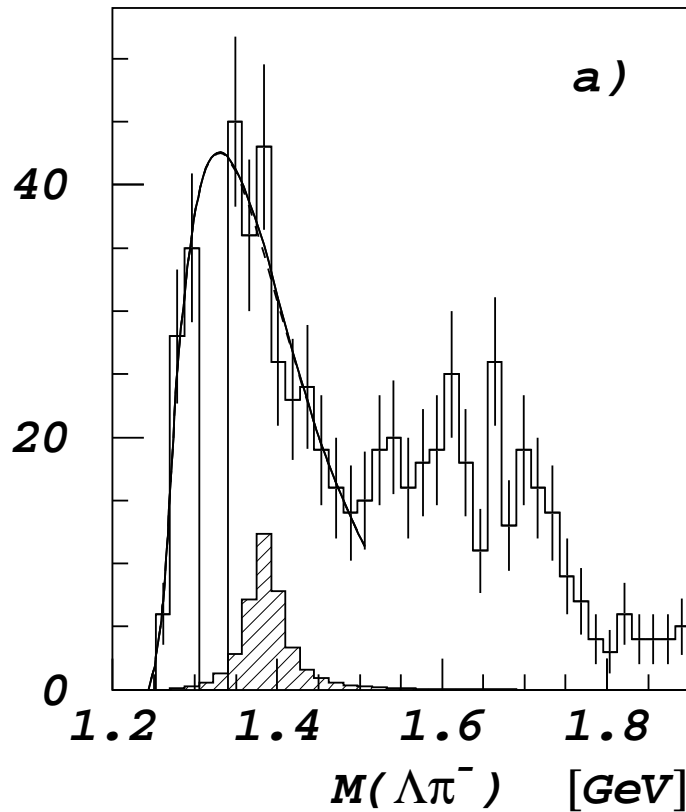

- No clear evidence for $\Sigma(1385)^-$ production \implies only an upper limit

$$\Gamma[\Sigma(1385)^- \rightarrow \Sigma^- \gamma] < 9.5 \text{ keV} \quad (90\% \text{ CL})$$

Predictions for $\Sigma(1385)^- \rightarrow \Sigma^- \gamma$

SU(3/6) breaking			1–7
MIT bag	R.H.Hackman...	PR D18(1978)2637.	1.5
NRQM	J.W.Darewych...	PR D28(1983)1125	2.5
HB χ PT	M.N.Butler...	NP B399(1993)69	1.6–2.4
HB χ PT	M.Napsuciale...	NP B494(1997)260	9.5
Quenched lattice	D.B.Leinweber...	PR D48(1993)2230	3.3 ± 1.2
field-theoretic QM	R.K.Sahoo...	PR D52(1995)4099	2.5
bound-state soliton	C.L.Schat...	PL B356(1995)1.	1
3-flavor Skyrme	A.Abada...	PL B366(1996)26	1; 2
3-flavor Skyrme	T.Haberichter...	NP A615(1997)291	1.17–2.27
χ CQM / exch. curr.	G.Wagner...	PR C58(1998)1745	3.61
χ CQM / exch. curr.	G.Wagner...	J.Phys. G26(2000)267	3.1
$1/N_c$ expansion	R.F.Lebed...	PR D70(2004)057901	0.58 ± 0.70
light cone QCD	T.M.Aliev...	hep-ph/0406331	0.38 ± 0.06
Bonn CQM	T.VanCauteren...	nucl-th/0509047	11.7

SPHINX Detector

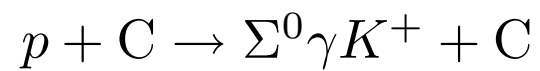
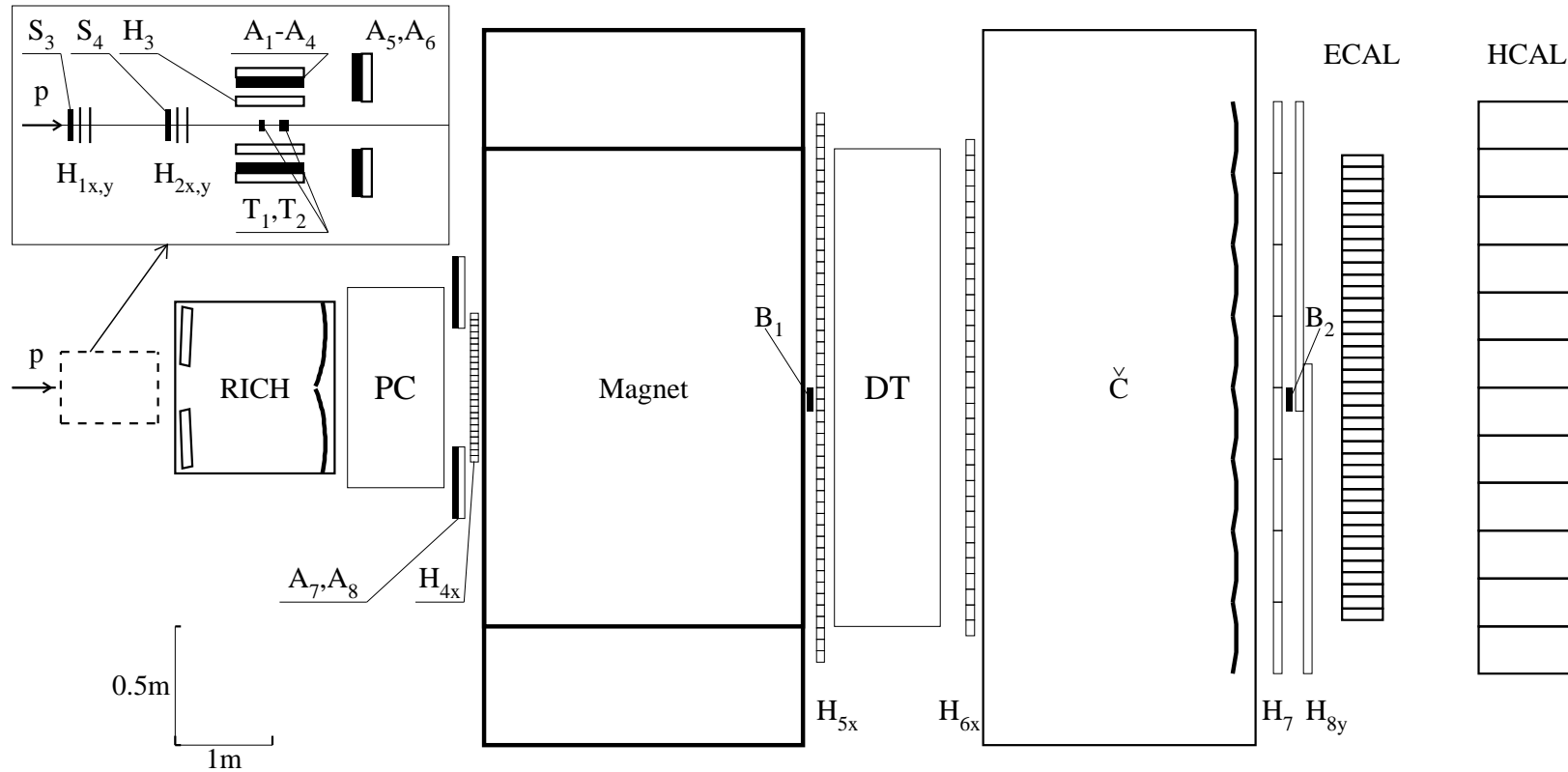

SPHINX: $\Lambda(1520) \rightarrow \Lambda\gamma$

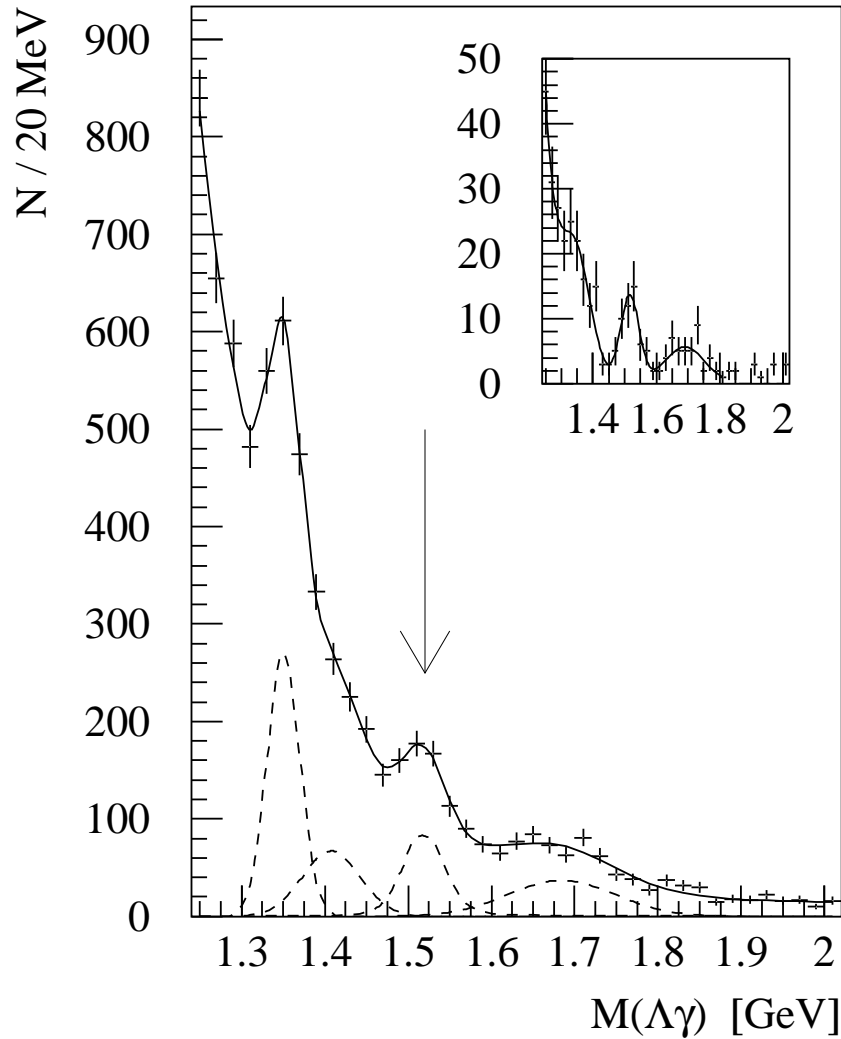

Backgrounds:

- $\Sigma(1385)^0 \rightarrow \Lambda\pi^0$ (1 γ lost)
- $\Lambda(1405) \rightarrow \Sigma^0\pi^0$ (2 γ lost)
- $\Lambda(16xx), \Sigma(16xx)^0$
- $\Lambda(1520) \rightarrow \Sigma^0\pi^0$ (2 γ lost)
- $\Lambda(1520) \rightarrow \Sigma^0\gamma$ (1 γ lost)

$$\Gamma[\Lambda(1520) \rightarrow \Lambda\gamma] = 159 \pm 33 \pm 26 \text{ keV}$$

SPHINX: $\Lambda(1520) \rightarrow \Sigma^0 \gamma$

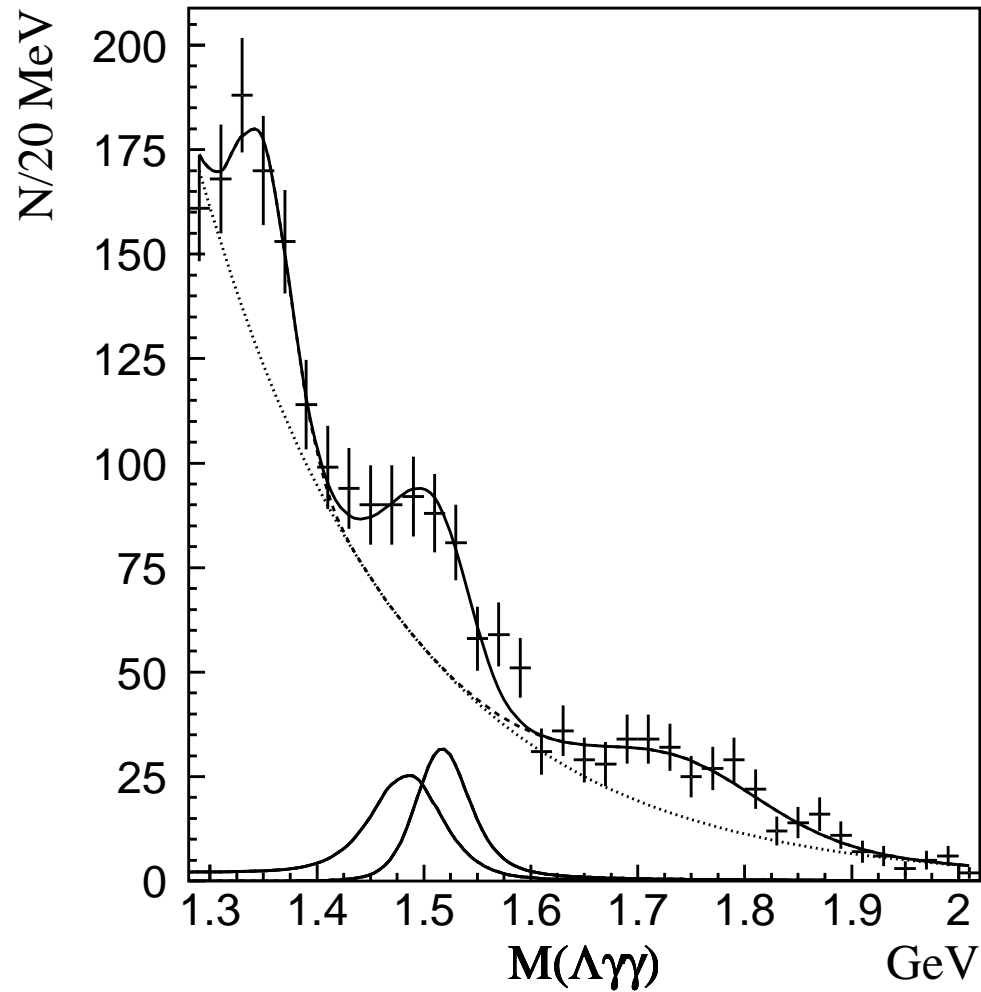

Backgrounds:

- $\Lambda(1405) \rightarrow \Sigma^0 \pi^0$
- $\Lambda(16xx) \rightarrow \Sigma^0 \pi^0$
- $\Lambda(1520) \rightarrow \Sigma^0 \pi^0$

Very preliminary:

$$\Gamma[\Lambda(1520) \rightarrow \Sigma^0 \gamma] \sim 130 \text{ keV}$$

CLAS Detector

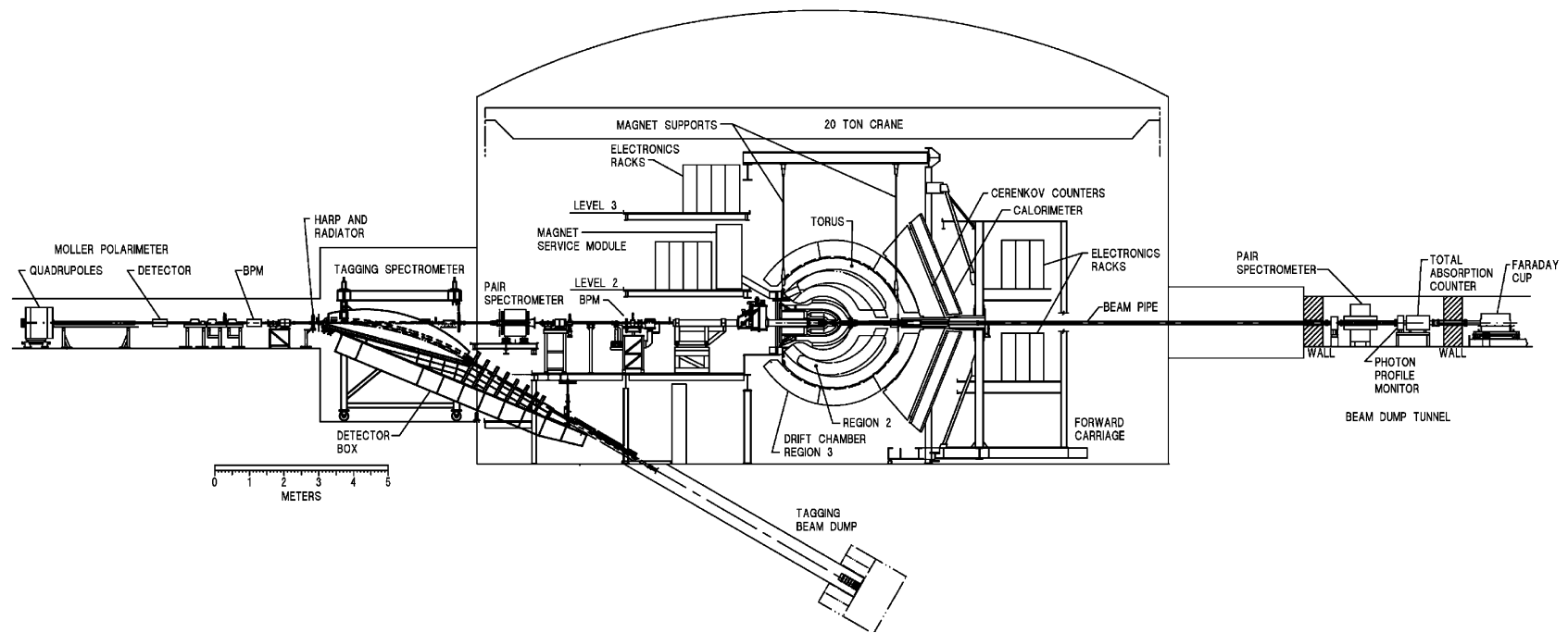
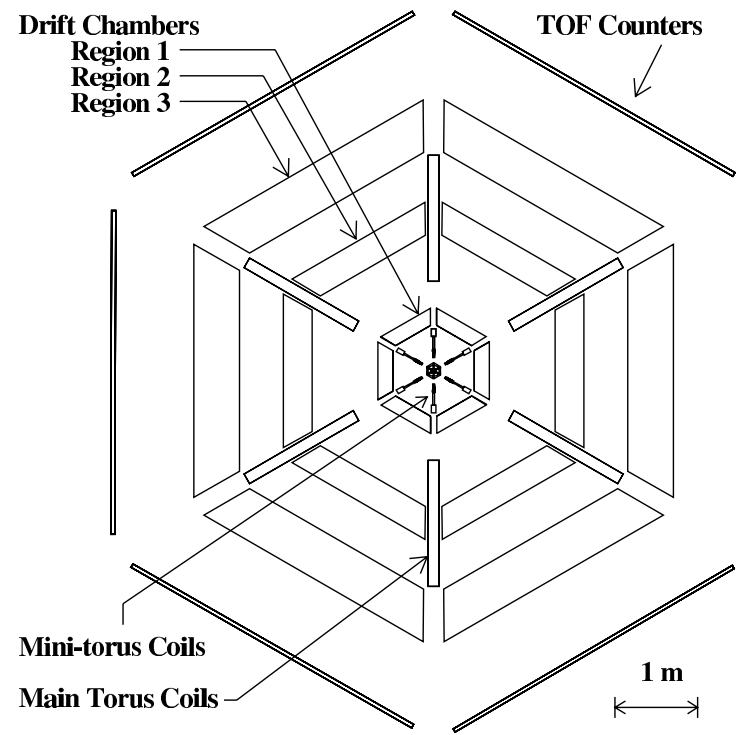
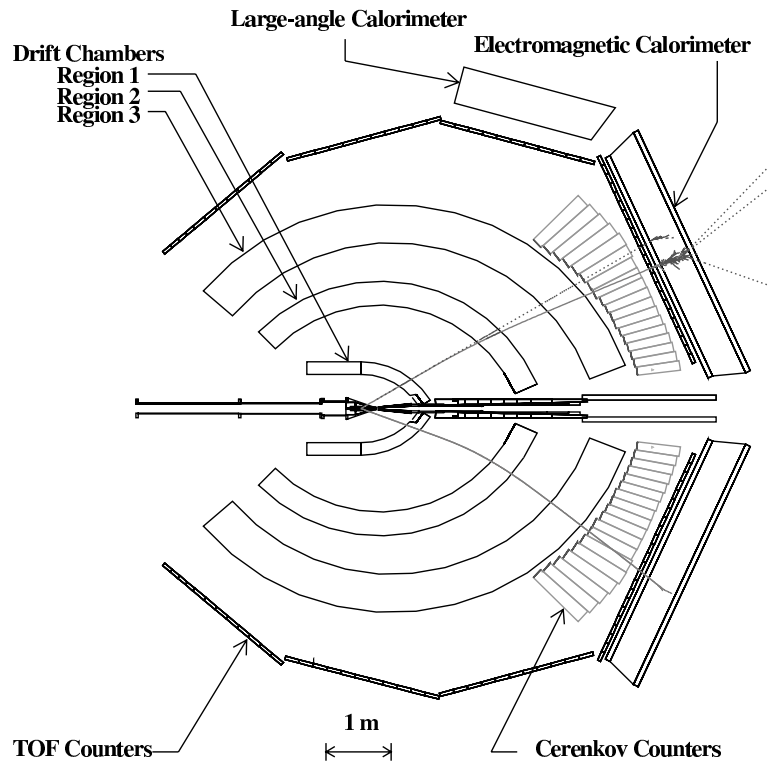

Fig. 2. Side view of the CLAS detector in Hall B with beamline and associated equipment.

CLAS Detector



Toroidal magnetic field

CLAS Detector Parameters

- Datataking: September-October 1999
- Target: liquid H₂
- Primary beam
 - Electron energy 2.445, 2.897 and 3.115 GeV
 - Photon energy 20–95% of the electron
 - Photon resolution $\Delta E/E = 1 \cdot 10^{-3}$
- Particle ID
 - π/K separation $p \leq 2$ GeV
 - π/p separation $p \leq 3.5$ GeV
- Resolutions
 - Momentum $\sigma(p)/p \approx 0.5\%$ for $\theta \lesssim 30^\circ$
 $\sigma(p)/p \approx (1-2)\%$ for $\theta \gtrsim 30^\circ$
 - Polar angle $\sigma(\theta) \approx 1$ mrad
 - Azimuthal angle $\sigma(\phi) \approx 4$ mrad
 - Photon energy $\sigma(E)/E \approx 10\%/\sqrt{E/\text{GeV}}$

CLAS Analysis

Only basic ideas are highlighted.

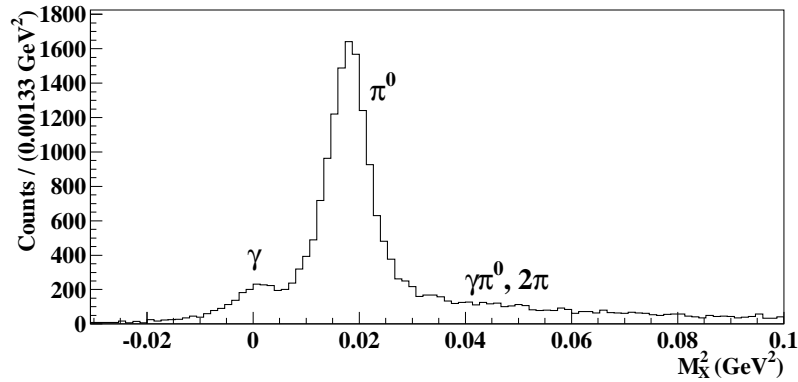
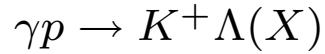
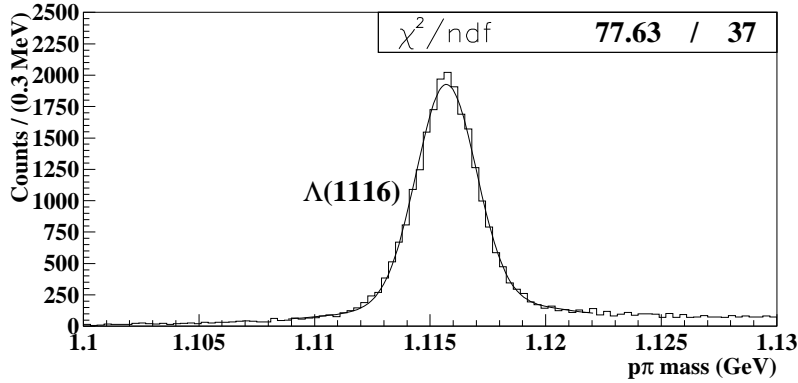
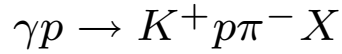
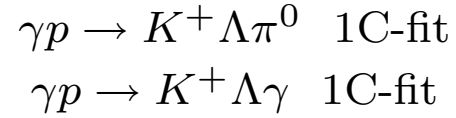

A: π^0 B: γ C: both D: neither

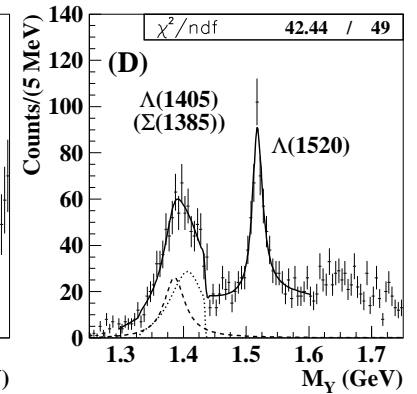
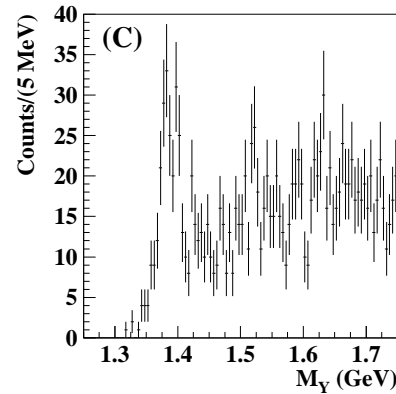
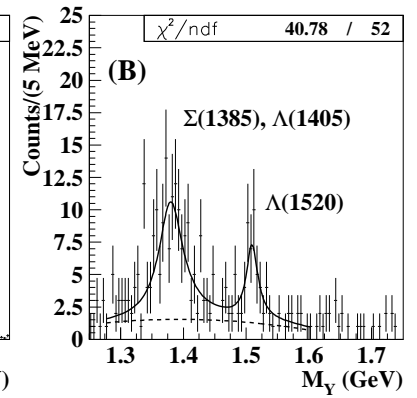
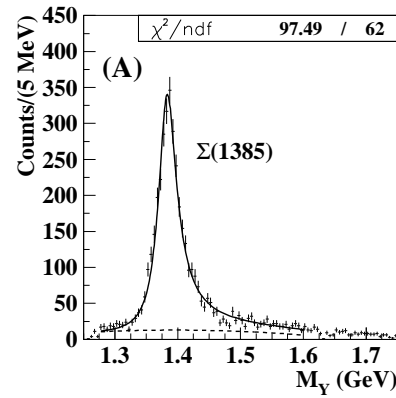

CLAS: $\Lambda(1520) \rightarrow \Lambda\gamma$

- Favourable background conditions

Reaction	A_π	A_γ	$A_{\gamma\pi}$
$\Lambda(1405) \rightarrow \Sigma^0 \pi^0$	0.083 ± 0.004	0.0007 ± 0.0004	0.658 ± 0.012
$\Lambda(1405) \rightarrow \Sigma^+ \pi^-$	0.088 ± 0.005	0.0038 ± 0.0009	0.013 ± 0.002
$\Lambda(1405) \rightarrow \Lambda\gamma$	0.008 ± 0.003	0.946 ± 0.028	0.098 ± 0.009
$\Lambda(1405) \rightarrow \Sigma^0 \gamma$	0.585 ± 0.019	0.380 ± 0.015	0.837 ± 0.023
$\Sigma(1385) \rightarrow \Lambda\pi$	0.905 ± 0.010	0.011 ± 0.001	0.086 ± 0.003
$\Sigma(1385) \rightarrow \Sigma^+ \pi^-$	0.050 ± 0.002	0.0018 ± 0.0005	0.00564 ± 0.0008
$\Sigma(1385) \rightarrow \Lambda\gamma$	0.012 ± 0.002	1.309 ± 0.022	0.105 ± 0.006
$\Sigma(1385) \rightarrow \Sigma^0 \gamma$	0.548 ± 0.016	0.24 ± 0.01	0.99 ± 0.02
$\Lambda(1520) \rightarrow \Lambda\gamma$		1.388 ± 0.027	0.0010 ± 0.0007
$\Lambda(1520) \rightarrow \Sigma^0 \gamma$		0.087 ± 0.006	0.586 ± 0.016
$\Lambda(1520) \rightarrow \Lambda\pi^0 \pi^0$		0	0.0099 ± 0.0016
$\Lambda(1520) \rightarrow \Sigma^0 \pi^0$		0.0006 ± 0.0004	0.681 ± 0.014

Acceptances in units of 10^{-3}

$$\Gamma[\Lambda(1520) \rightarrow \Lambda\gamma] = 167 \pm 43_{-12}^{+26} \text{ keV}$$

CLAS: $\Sigma(1385)^0 \rightarrow \Lambda\gamma$

Much more complex than the $\Lambda(1520)$ case.

There is a background due to $\Lambda(1405) \rightarrow \Lambda\gamma$.

Fortunately, this width is measured to be 27 ± 8 keV.

Ignoring contribution due to $\Sigma(1385)^0 \rightarrow \Sigma^0\gamma$ decay:

$$\Gamma[\Sigma(1385)^0 \rightarrow \Lambda\gamma] = 479 \pm 120^{+81}_{-100} \text{ keV}$$

This is 2–3 times larger than most model predictions

Predictions for $\Lambda(1520)$ and $\Sigma(1385)^0 \rightarrow \Lambda\gamma$

			$\Sigma(1385)^0$	$\Lambda(1520)$
MIT bag	R.H.Hackman...	PR D18(1978)2637.	211; 191	
MIT bag	E.Kaxiras...	PR D32(1985)695	152	46; 27
NRQM	J.W.Darewych...	PR D28(1983)1125	232	96
RQM	M.Warns...	PL B258(1991)431	267	215
chiral bag	Y.Umino...	NP A554(1993)593		31.46
HB χ PT	M.N.Butler...	NP B399(1993)69	290–470	
bound-state soliton	C.L.Schat...	PL B356(1995)1.	243; 170	
3-flavor Skyrme	A.Abada...	PL B366(1996)26	180–209	
3-flavor Skyrme	T.Haberichter...	NP A615(1997)291	157–209	
χ CQM / exch. curr.	G.Wagner...	PR C58(1998)1745	265	
χ CQM / exch. curr.	G.Wagner...	J.Phys. G26(2000)267	249	
algebraic model	R.Bijker	Annals Phys. 284(2000)89	221.3	85.1
$1/N_c$ expansion	R.F.Lebed...	PR D70(2004)057901	298 ± 25	
light cone QCD	T.M.Aliev...	hep-ph/0406331	140 ± 20	
Bonn CQM	T.VanCauteren...	nucl-th/0509047	1527	258

From 1996 To 2005

Decay	1996	2005
$\Sigma^0 \rightarrow \Lambda\gamma$	●	
$\Sigma(1385)^+ \rightarrow \Sigma^+\gamma$		
$\Sigma(1385)^- \rightarrow \Sigma^-\gamma$	*	*
$\Sigma(1385)^0 \rightarrow \Sigma^0\gamma$	*	
$\Sigma(1385)^0 \rightarrow \Lambda\gamma$	*	●
$\Lambda(1405) \rightarrow \Sigma(1385)^0\gamma$		
$\Lambda(1405) \rightarrow \Sigma^0\gamma$	●	
$\Lambda(1405) \rightarrow \Lambda\gamma$	●	
$\Lambda(1520) \rightarrow \Lambda(1405)\gamma$		
$\Lambda(1520) \rightarrow \Sigma(1385)^0\gamma$		
$\Lambda(1520) \rightarrow \Sigma^0\gamma$	●	??
$\Lambda(1520) \rightarrow \Lambda\gamma$	●	●
$\Xi(1530)^- \rightarrow \Xi^-\gamma$		
$\Xi(1530)^0 \rightarrow \Xi^0\gamma$		

Experimental Perspectives in 1996

Summarized by LGL in 1996 review:

- Primakoff production (SELEX)

$$\Sigma^\pm \rightarrow \Sigma(1385)^\pm$$

$$\bar{\Sigma}^- \rightarrow \overline{\Sigma(1385)}^-$$

$$\Xi^- \rightarrow \Xi(1530)^-$$

$$\Xi^- \rightarrow \Xi(1820)^-$$

- Direct observation in exclusive production (SELEX, SPHINX)

$$\Sigma^- + N \rightarrow \Lambda^*(\Sigma^*)\pi + N$$

$$p + N \rightarrow \Lambda^*(\Sigma^*)K + N$$

- Virtual photon beam (CLAS)

$$e^- + p \rightarrow e^- + \Lambda K^+ \quad \text{study } \Lambda\gamma^* \text{ near } \Lambda(1405)$$

These perspectives are now realized: SELEX performed worse than expected, SPHINX more or less as expected, CLAS better than expected.

Perspectives

SELEX, SPHINX, CLAS exhausted their possibilities (completely?)

Wait for lattice

No hyperon beam is planned anywhere

Production reactions in other beams

- JLAB Hall D γ beam

There is a proposal to search for exotic mesons.

There could be a place for hyperon EM decays as well.

- U-70 OKA K^- beam

Can produce lots of hyperons.

How to detect EM decays? Exclusive reactions.

Liquid H₂ target combined with good guard system.

- Any p beam

Like SPHINX, only x10 better.

The question LGL would ask is:

how can we take part in that game?

Speculations

How to make x10 better proton experiment in Protvino?

SPHINX was built about 20 years ago. There has been significant progress in detector technology. In particular, it is connected with development of kaon experiments. Great deal of that expertise is concentrated in IHEP.

Increase signals and lower backgrounds:

- increase statistics running time
 beam rate (≈ 230 MHz in Kplus)
 DAQ (OKA, CKM)
- improve resolutions microstrips (SVD)
 straw tubes ($\sigma \approx 150 \mu\text{m}$ in Kplus)
 ECAL (KOPIO: $\sigma(E)/E \approx 3\%/\sqrt{E/\text{GeV}}$)
- improve veto system Pb/scintillator sandwich (KOPIO: ≈ 1 MeV)
- improve analysis polarization measurement in $\Lambda \rightarrow p\pi^-$, $\Sigma^+ \rightarrow p\pi^0$
 polarized beam (planned at IHEP) allows PWA
- improve veto MC measure veto time and amplitude (CKM)

Technically feasible.